

Schuko

absaugen · filtern · fördern · brikettieren · zerkleinern

**liefert moderne Absaugtechnik
für die
holzverarbeitende
Industrie und
Handwerk**

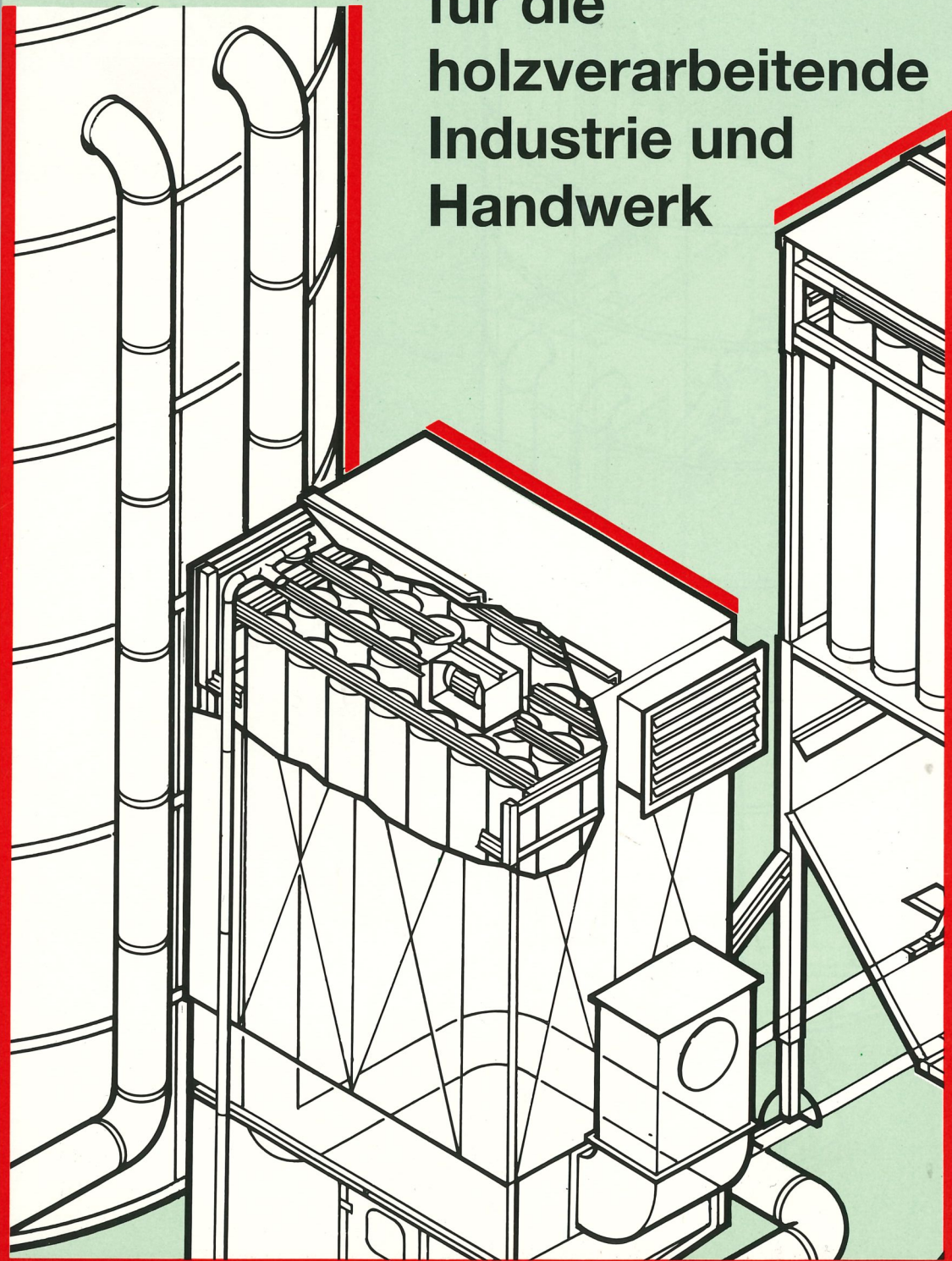

Schuko

Filterabreinigungssysteme – Rüttelautomatik

– Spülluft



Zwischenfilteranlage
mit Transportsystem
zum Spänesilo

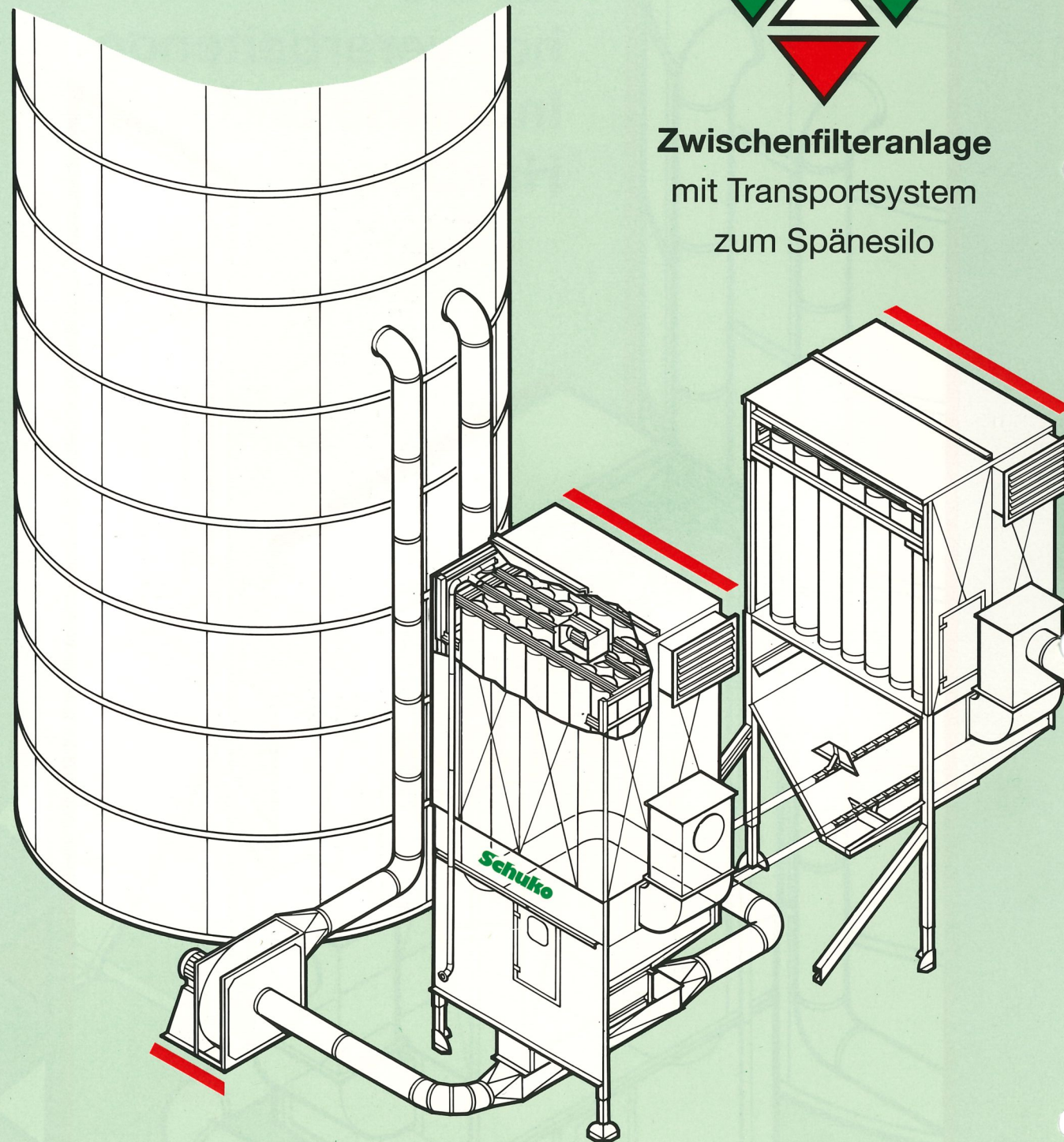

Brikketierpresse

mit
Schubboden
und
Aufsatzfilter

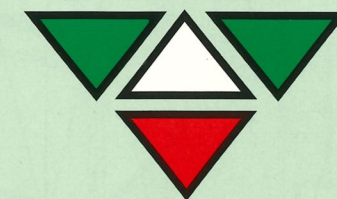
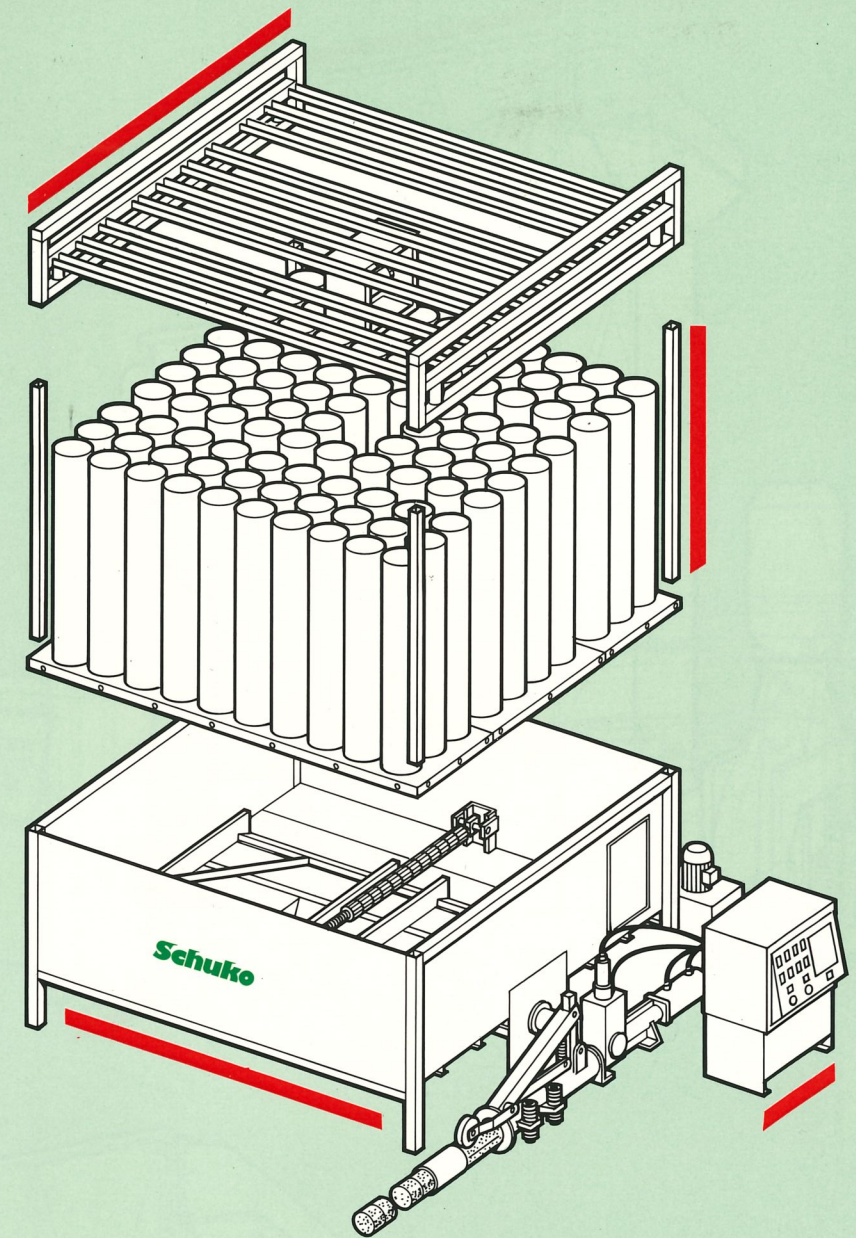

Absackanlage

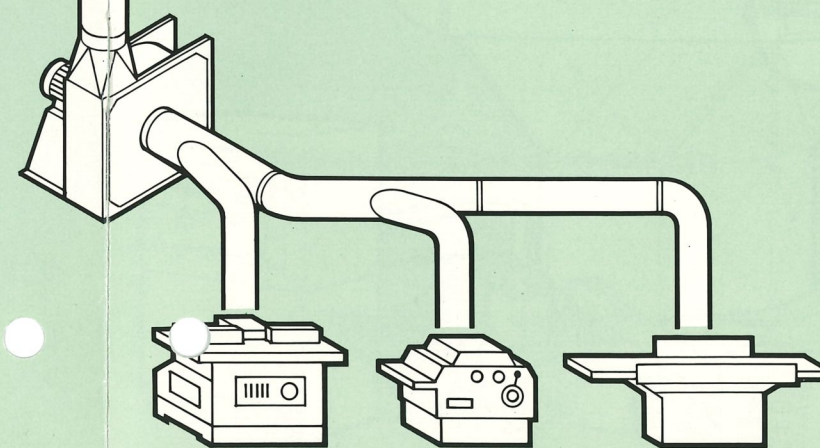



Schuko

Vakuum-Filteranlagen

erfüllen
die Anforderungen
der Holz BG

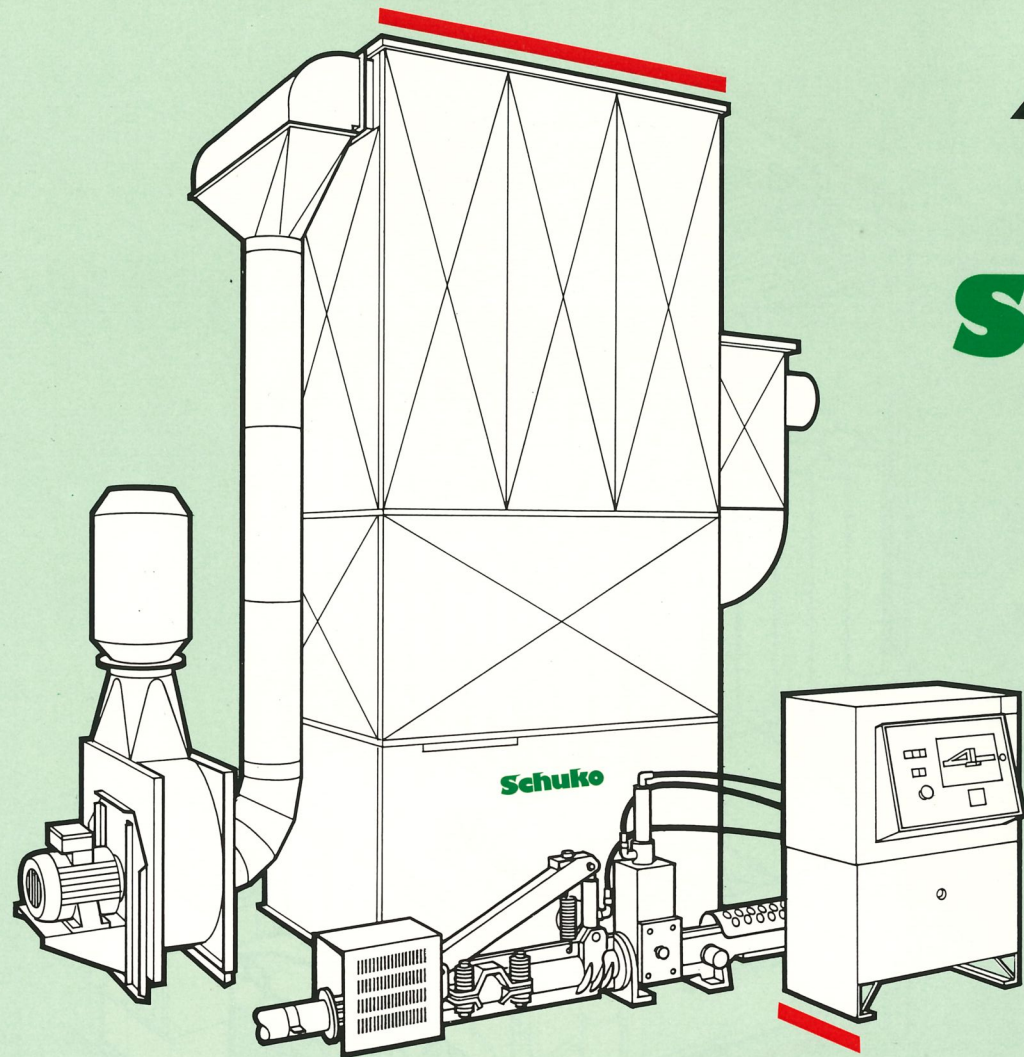

Vakuum-
Filteranlage
mit Schubboden
und
Brikettierpresse



CE

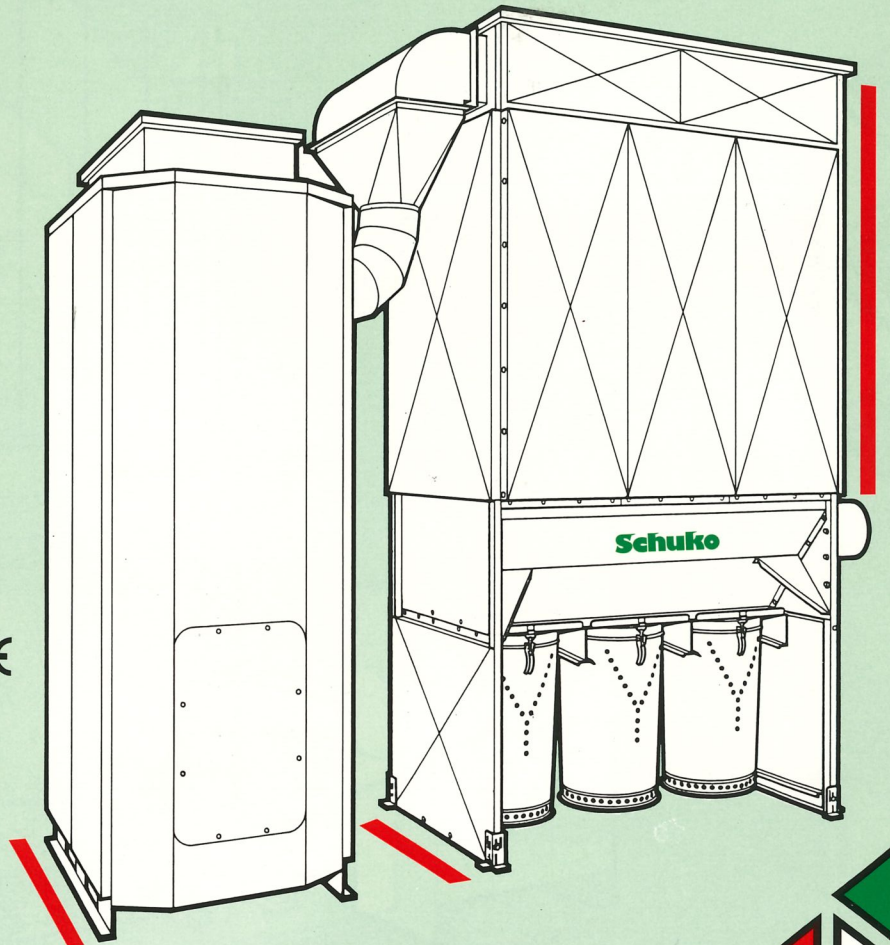

Vakuum-Absackanlage



Vakuum-
Filteranlage
mit
Spänebehälter
SPB 1420

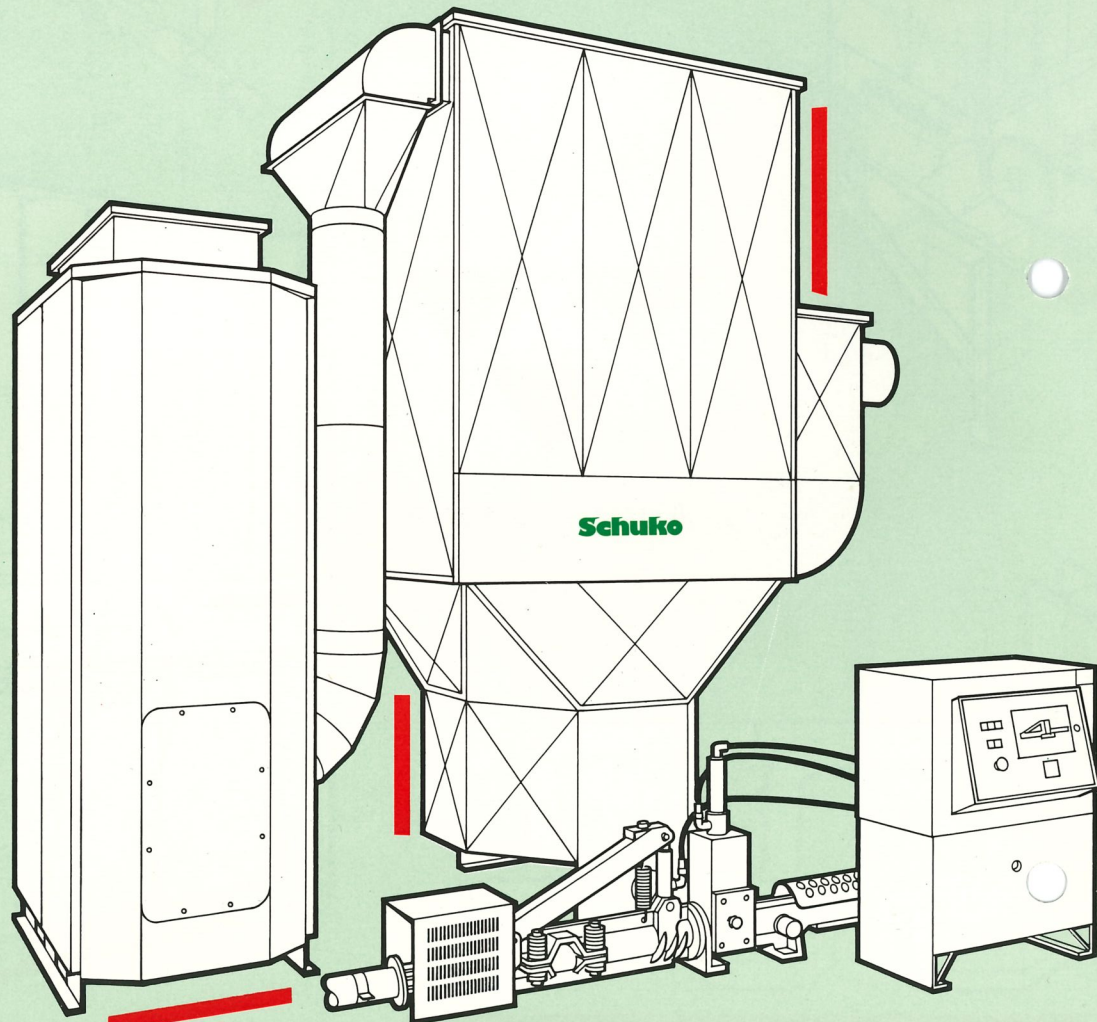

H2
Geeignet zur
Abscheidung
von Holzstaub
Feinstaub-
gehaltstufe 2
0,2 mg/m³
sicher eingehalten
+ CE



Vakuum-Absauggeräte

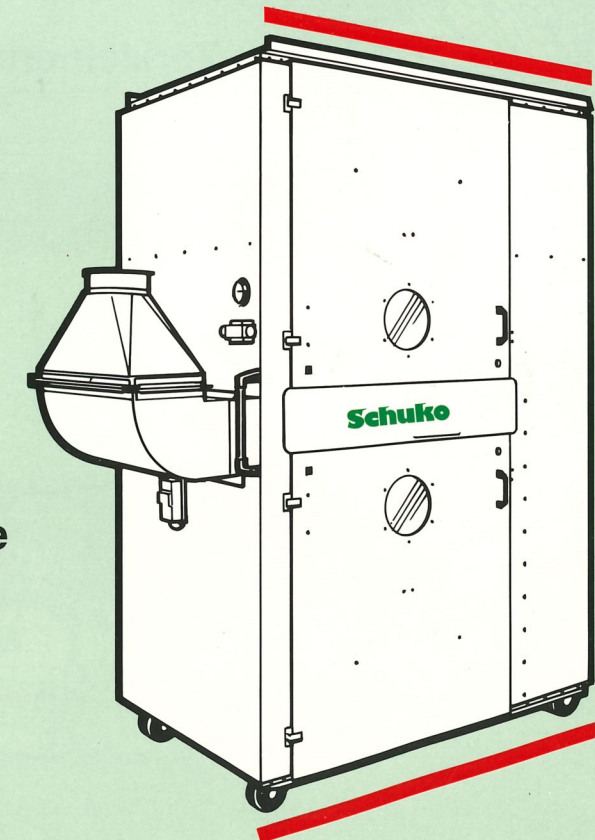

H2
Geeignet zur
Abscheidung
von Holzstaub
Feinstaub-
gehaltstufe 2
0,2 mg/m³
sicher eingehalten
+ CE



Absackanlage mit Brikettierpresse

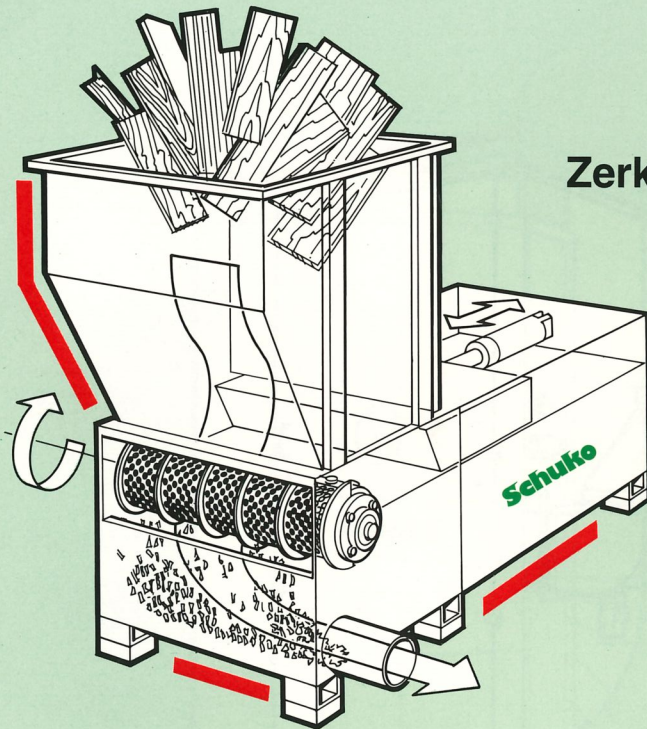
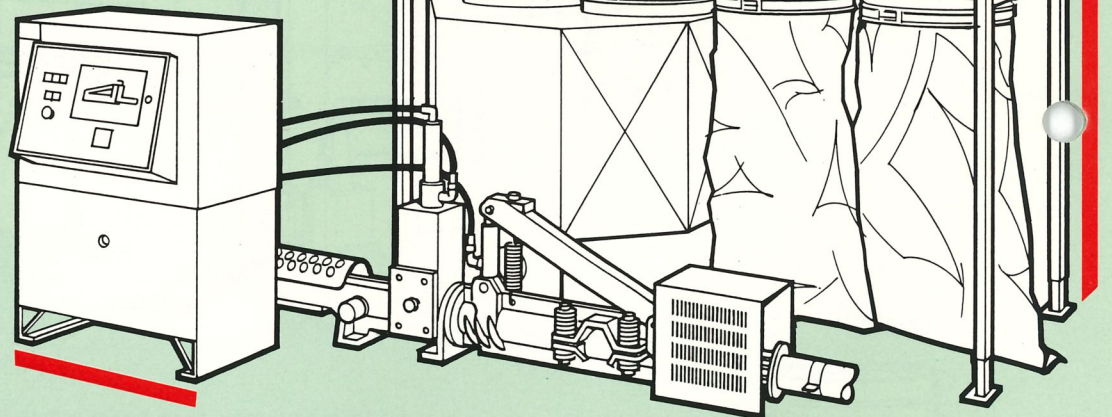

Zerkleinerungsmaschinen für Holzabfälle

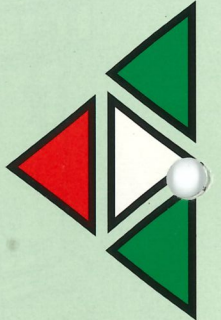
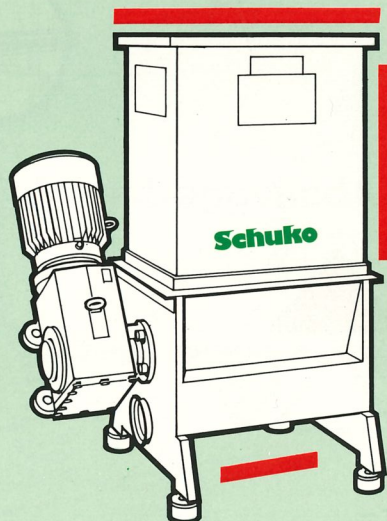

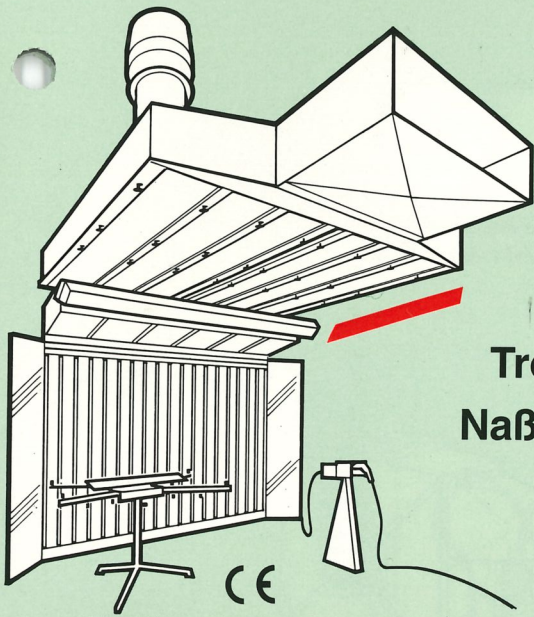

Trocken- und
Naßspritzwände

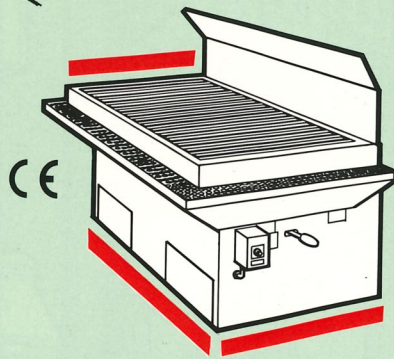
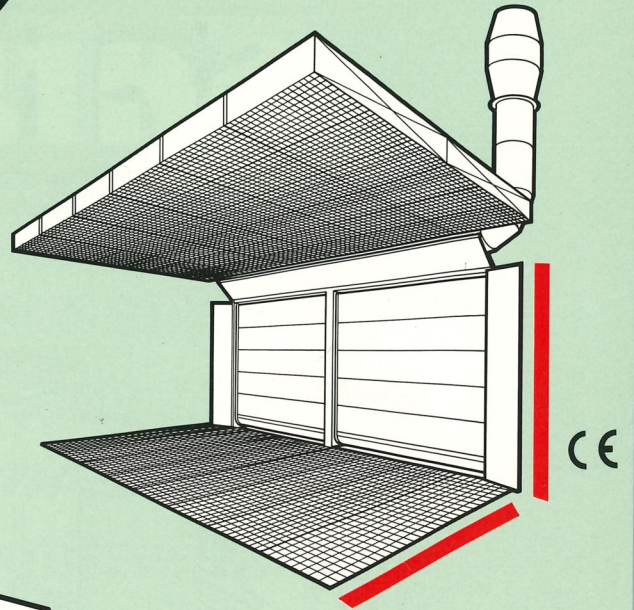

Schleiftische

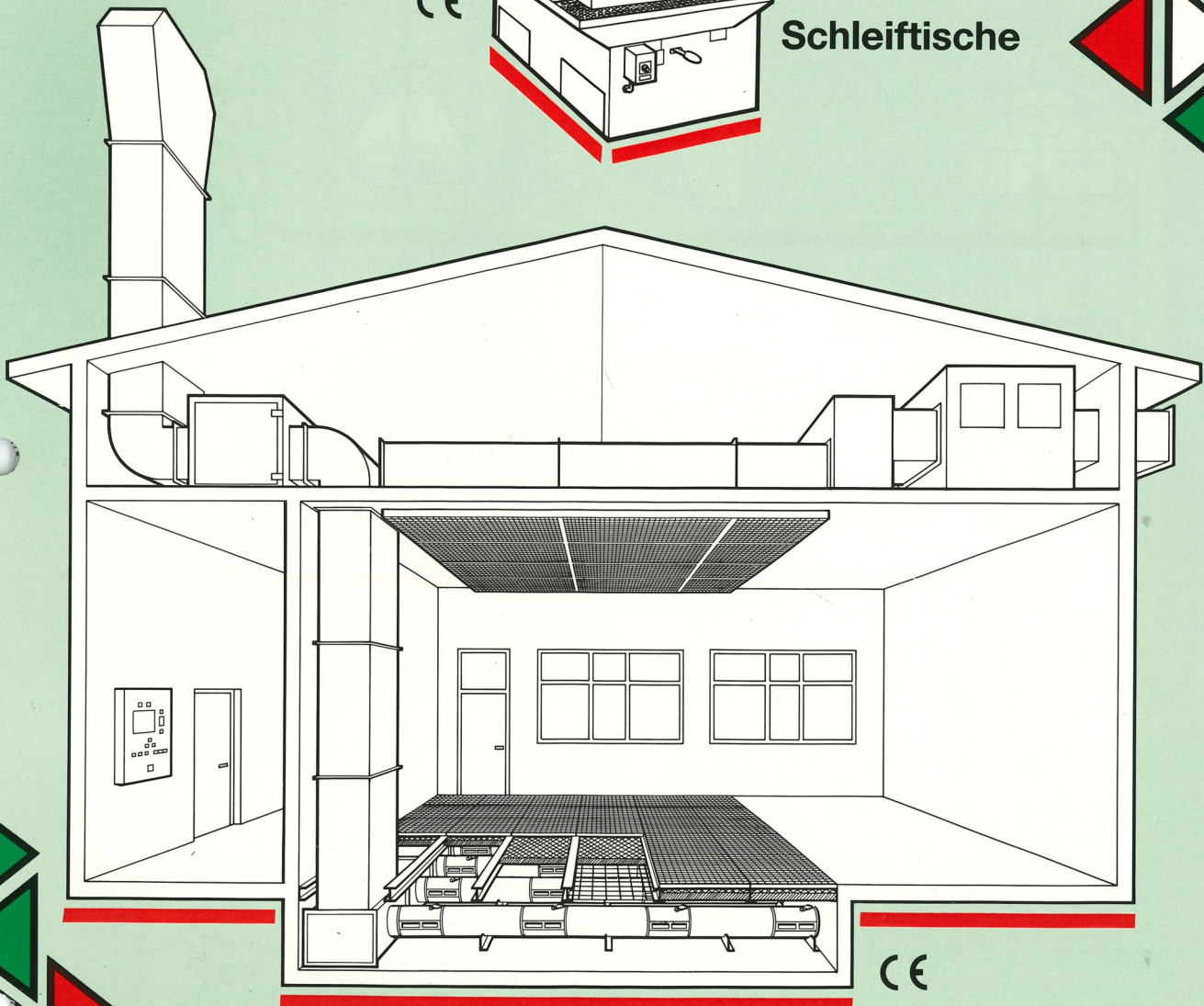
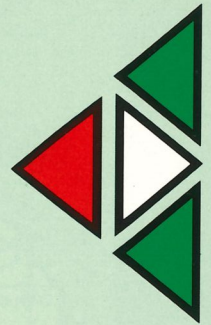

Underfloor Absaugsystem
für Lackerräume



Schuko

absaugen · filtern · fördern · brikettieren · zerkleinern

Ventilatoren (CE)

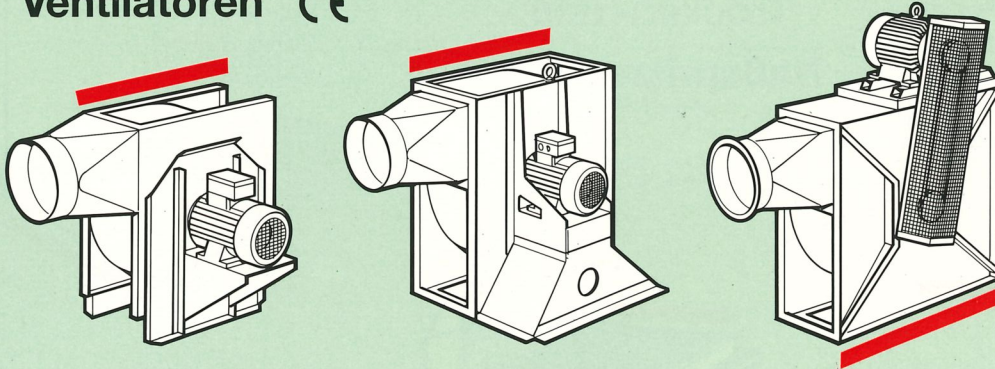

Bauteile

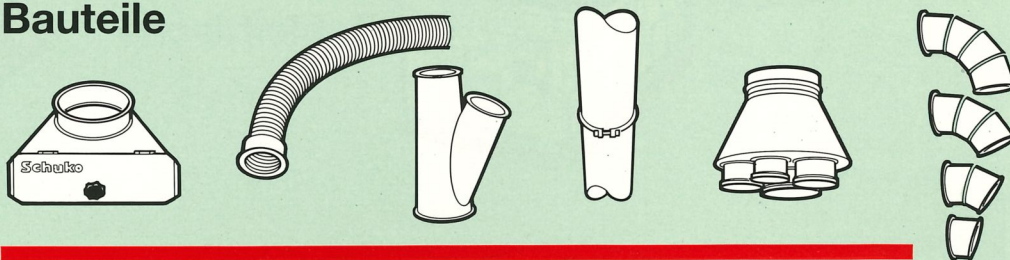

Absperrschieber

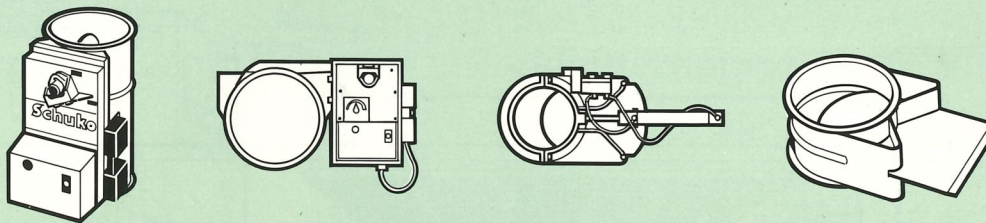

— 5 Produktionswerke garantieren —
kurze Lieferwege u. preiswerte Produkte

Schuko

H. Schulte-Südhoff GmbH + Co. KG

D-97478 Knetzgau, Industriestraße 22
Telefon 0 95 27 / 9 22 80, Telefax 73 34

D-88348 Saulgau, Mackstraße 18, Tel. 0 75 81/48 71-0, Fax 48 71-81

D-49193 Bad Laer, Postfach 1249, Tel. 0 54 24/806-0, Fax 806-80

D-55481 Kirchberg/H., Hugo-Wagener-Str., Tel. 0 67 63/501, Fax 504

D-14959 Trebbin, Zossener Str. 4, Tel. 03 37 31/86 70, Fax 8 67 55